

Voltage transducer DVL 750

$V_{PN} = 750\text{ V}$

For the electronic measurement of voltage: DC, AC, pulsed..., with galvanic isolation between the primary and the secondary circuit.

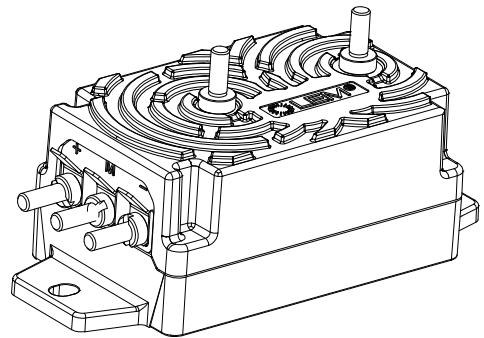

Features

- Bipolar and isolated measurement up to 1125 V
- Current output
- Input and output connections with M5 studs
- Compatible with AV 100 family.

Advantages

- Low consumption and low losses
- Compact design
- Good behavior under common mode variations
- Excellent accuracy (offset, sensitivity, linearity)
- Good response time
- Low temperature drift
- High immunity to external interferences.

Applications

- Single or three phase inverter
- Propulsion and braking chopper
- Propulsion converter
- Auxiliary converter
- High power drives
- Substations.

Standards

- EN 50155
- EN 50178
- EN 50121-3-2
- EN 50124-1
- Isolated plastic case material recognized according to UL 94-VO.

Application Domain

- Traction (fixed and onboard)
- Industrial.

Absolute maximum ratings

Parameter	Symbol	Value
Maximum supply voltage ($V_p = 0, 0.1 \text{ s}$)		$\pm 34 \text{ V}$
Maximum supply voltage (working) (-40 .. 85 °C)	$\pm V_C$	$\pm 26.4 \text{ V}$
Maximum input voltage (-40 .. 85 °C)		1125 V
Maximum steady state input voltage (-40 .. 85 °C)	V_{PN}	750 V see derating on figure 2

Absolute maximum ratings apply at 25°C unless otherwise noted.

Stresses above these ratings may cause permanent damage. Exposure to absolute maximum ratings for extended periods may degrade reliability.

Isolation characteristics

Parameter	Symbol	Unit	Min	Comment
RMS voltage for AC isolation test 50/60Hz/1 min	V_d	kV	8.5	100 % tested in production
Maximum impulse test voltage (1.2/50 μs exponential shape)		kV	12	
Isolation resistance	R_{IS}	M Ω	200	measured at 500 V DC
Partial discharge extinction voltage rms @ 10 pC	V_e	V	2700	
Comparative tracking index	CTI	V	600	
Clearance and creepage	See dimensions drawing on page 8			

Environmental and mechanical characteristics

Parameter	Symbol	Unit	Min	Typ	Max
Ambient operating temperature	T_A	°C	-40		85
Ambient storage temperature	T_S	°C	-50		90
Mass	m	g		270	
Standards	EN 50155: 2007 EN 50121-3-2:2006 EN 50124-1: 2001 EN 50178: 1997				

Electrical data DVL 750

At $T_A = 25^\circ\text{C}$, $\pm V_C = \pm 24\text{ V}$, $R_M = 100\ \Omega$, unless otherwise noted.

Lines with a * in the conditions column apply over the $-40 \dots 85^\circ\text{C}$ ambient temperature range.

Parameter	Symbol	Unit	Min	Typ	Max	Conditions
Primary nominal voltage, rms	V_{PN}	V		750		*
Primary voltage, measuring range	V_{PM}	V	-1125		1125	*
Measuring resistance	R_M	Ω	0		120	* See derating on figure 2. For $ V_{PM} < 1125\text{ V}$, max value of R_M is given on figure 1
Secondary nominal current, rms	I_{SN}	mA		50		*
Output range	I_S	mA	-75		75	*
Supply voltage	$\pm V_C$	V	± 13.5	± 24	± 26.4	*
Supply rise time (10-90%)		ms			100	
Current consumption @ $V_C = \pm 24\text{ V}$	I_C	mA		$20 + I_S$	$25 + I_S$	
Offset current	I_O	μA	-50	0	50	100% tested in production
Offset drift	I_{OT}	μA	-120 -150		120 150	-25 .. 85 °C -40 .. 85 °C
Sensitivity	G	$\mu\text{A/V}$		66.66		50 mA for 750 V
Sensitivity error	ε_G	%	-0.2	0	0.2	
Thermal drift of sensitivity	ε_{GT}	%	-0.5		0.5	*
Linearity error	ε_L	%	-0.5		0.5	* $\pm 1125\text{ V}$ range
Overall accuracy	X_G	% of V_{PN}	-0.5 -1		0.5 1	25°C; 100% tested in production -40 .. 85 °C *
Output current noise, rms	i_{no}	μA_{rms}		10		1 Hz to 100 kHz
Reaction time @ 10 % of V_{PN}	t_{ra}	μs		30		
Response time @ 90 % of V_{PN}	t_r	μs		50	60	0 to 750 V step, 6 kV/ μs
Frequency bandwidth	BW	kHz		14 8 2		-3 dB -1 dB -0.1 dB
Start-up time		ms		190	250	*
Primary resistance	R_1	$M\Omega$		11.3		*
Total primary power loss @ V_{PN}	P	W		0.05		*

Typical performance characteristics

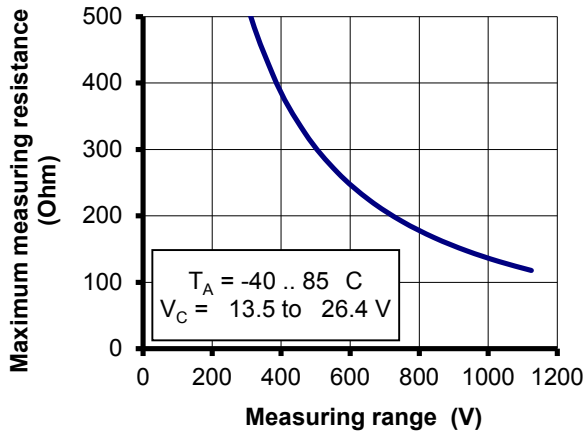

Figure 1: Maximum measuring resistance

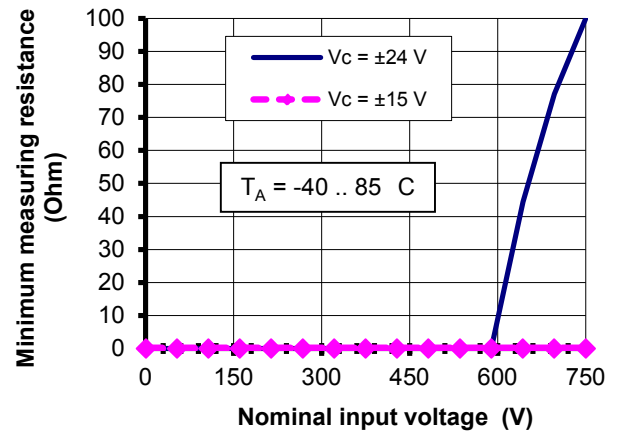

Figure 2: Minimum measuring resistance; For T_A under 80°C , the minimum measuring resistance is 0Ω whatever V_C

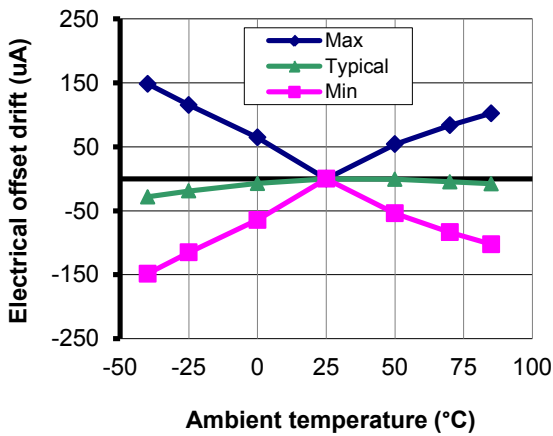

Figure 3: Electrical offset thermal drift

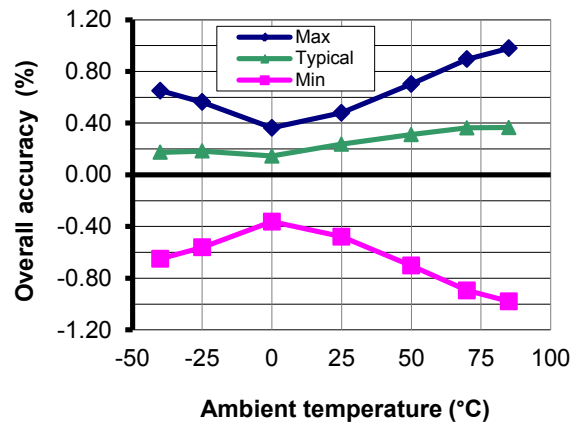

Figure 4: Overall accuracy in temperature

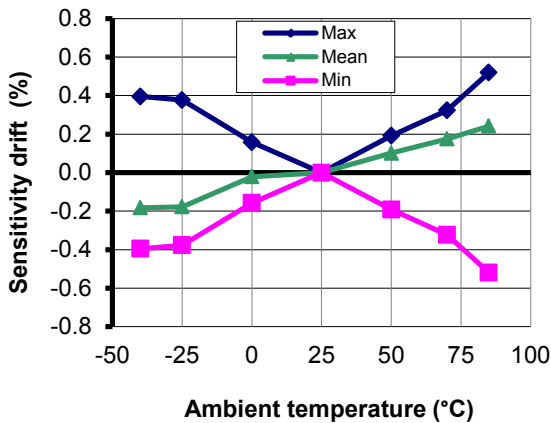

Figure 5: Sensitivity thermal drift

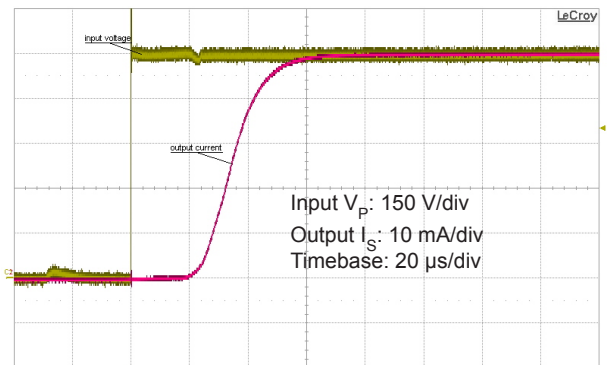

Figure 6: Typical step response (0 to 750 V)

Typical performance characteristics (continued)

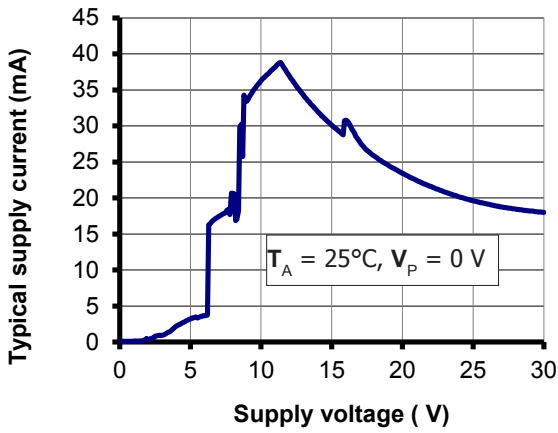

Figure 7: Supply current function of supply voltage

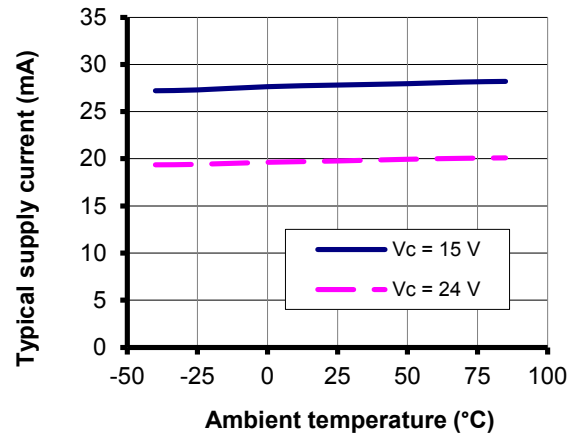

Figure 8: Supply current function of temperature

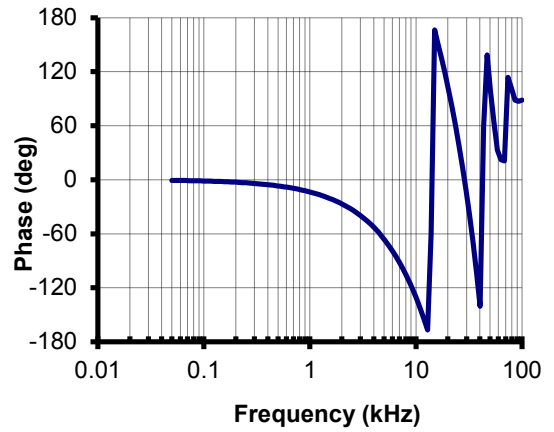
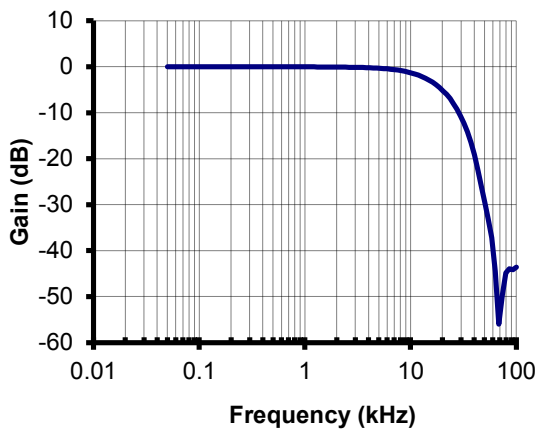

Figure 9: Typical frequency and phase response

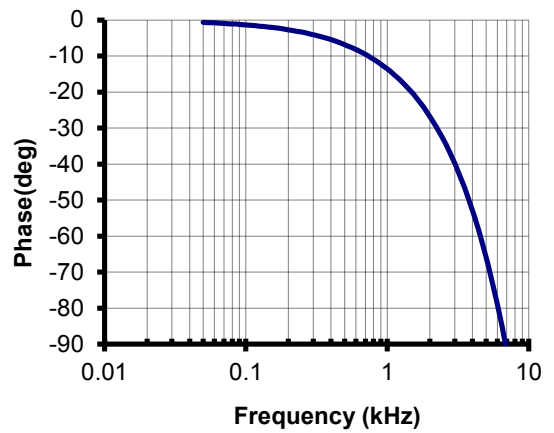
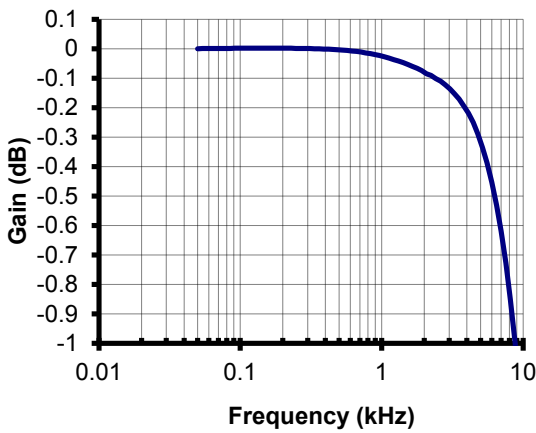

Figure 10: Typical frequency and phase response (detail)

Typical performance characteristics (continued)

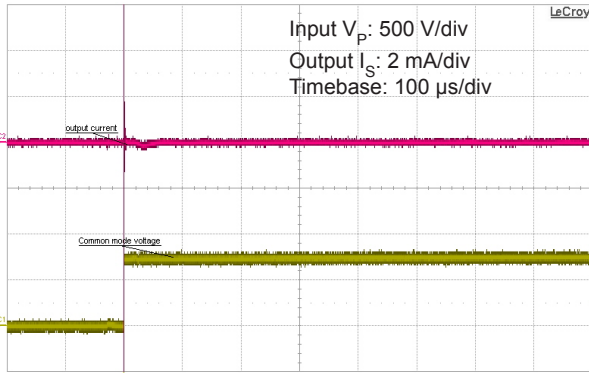

Figure 11: Typical common mode perturbation (750 V step with 6 kV/μs $R_M = 100 \Omega$)

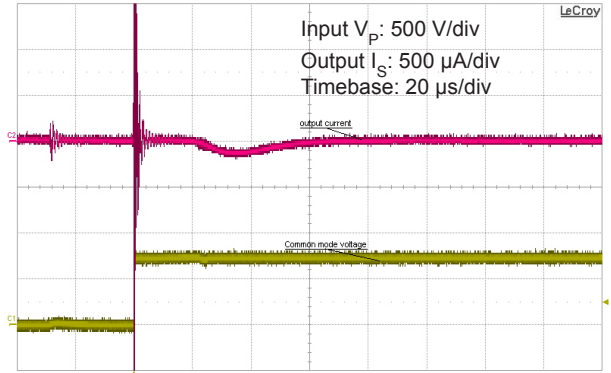

Figure 12: Detail of typical common mode perturbation (750 V step with 6 kV/μs, $R_M = 100 \Omega$)

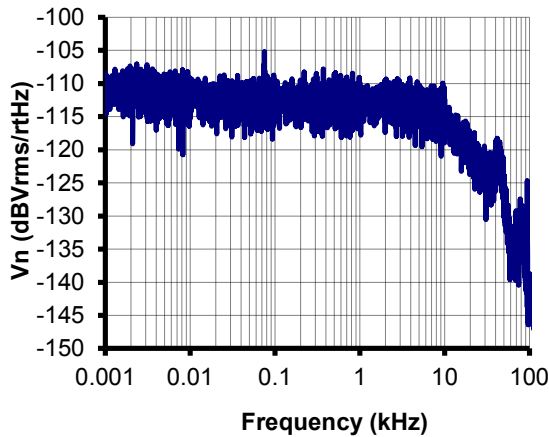

Figure 13: Typical noise power density of V (R_M) with $R_M = 50 \Omega$

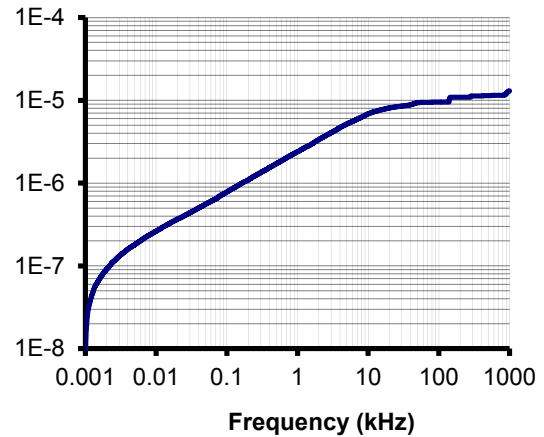

Figure 14: Typical total output current noise (rms) with $R_M = 50 \Omega$
(f_c is upper cut-off frequency of bandpass, low cut off frequency is 1 Hz)

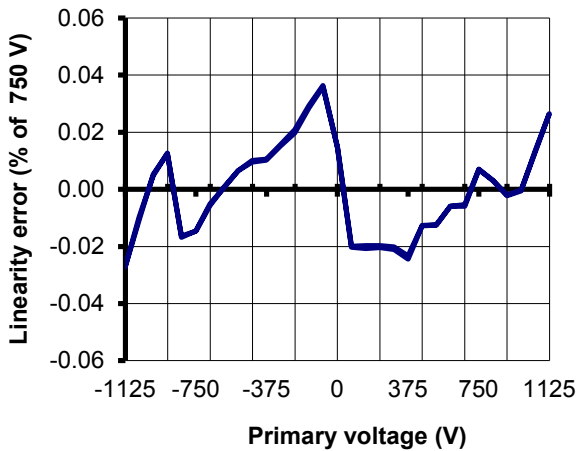

Figure 15: Typical linearity error at 25°C

Figure 13 (noise power density) shows that there are no significant discrete frequencies in the output.

Figure 14 confirms the absence of steps in the total output current noise that would indicate discrete frequencies. To calculate the noise in a frequency band f_1 to f_2 , the formula is

$$In(f_1 \text{ to } f_2) = \sqrt{In(f_2)^2 - In(f_1)^2}$$

with $In(f)$ read from figure 14 (typical, rms value).

Example:

What is the noise from 10 to 100 Hz?

Figure 14 gives $In(10 \text{ Hz}) = 0.26 \mu\text{A}$ and $In(100 \text{ Hz}) = 0.8 \mu\text{A}$.

The output current noise (rms) is therefore

$$\sqrt{(0.8 \cdot 10^{-6})^2 - (0.26 \cdot 10^{-6})^2} = 0.76 \mu\text{A}$$

Performance parameters definition

The schematic used to measure all electrical parameters are:

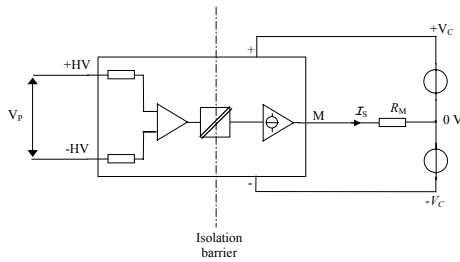

Figure 16: standard characterization schematics for current output transducers ($R_M = 50 \Omega$ unless otherwise noted)

Transducer simplified model

The static model of the transducer at temperature T_A is:

$$I_S = G V_P + \text{error}$$

In which

$$\text{error} = I_{OE} + I_{OT}(T_A) + \epsilon_G G V_P + \epsilon_{GT}(T_A) G V_P + \epsilon_L G V_{PM}$$

- I_S : the secondary current (A)
- G : the sensitivity of the transducer (A/V)
- V_P : the voltage to measure (V)
- V_{PM} : the measuring range (V)
- T_A : the ambient temperature ($^{\circ}\text{C}$)
- I_{OE} : the electrical offset current (A)
- $I_{OT}(T_A)$: the temperature variation of I_{OE} at temperature T_A (A)
- ϵ_G : the sensitivity error at 25°C
- $\epsilon_{GT}(T_A)$: the thermal drift of sensitivity at temperature T_A
- ϵ_L : the linearity error

This is the absolute maximum error. As all errors are independent, a more realistic way to calculate the error would be to use the following formula:

$$\text{error} = \sqrt{\sum (\text{error_component})^2}$$

Sensitivity and linearity

To measure sensitivity and linearity, the primary voltage (DC) is cycled from 0 to V_{PM} , then to $-V_{PM}$ and back to 0 (equally spaced $V_{PM}/10$ steps).

The sensitivity G is defined as the slope of the linear regression line for a cycle between $\pm V_{PM}$.

The linearity error ϵ_L is the maximum positive or negative difference between the measured points and the linear regression line, expressed in % of the maximum measured value.

Magnetic offset

Due to its working principle, this type of transducer has no magnetic offset current I_{OM} .

Electrical offset

The electrical offset current I_{OE} is the residual output current when the input voltage is zero.

The temperature variation I_{OT} of the electrical offset current I_{OE} is the variation of the electrical offset from 25°C to the considered temperature.

Overall accuracy

The overall accuracy X_G is the error at $\pm V_{PN}$, relative to the rated value V_{PN} . It includes all errors mentioned above.

Response and reaction times

The response time t_r and the reaction time t_{ra} are shown in the next figure.

Both slightly depend on the primary voltage dV/dt . They are measured at nominal voltage.

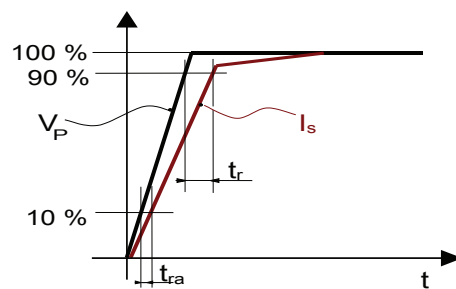
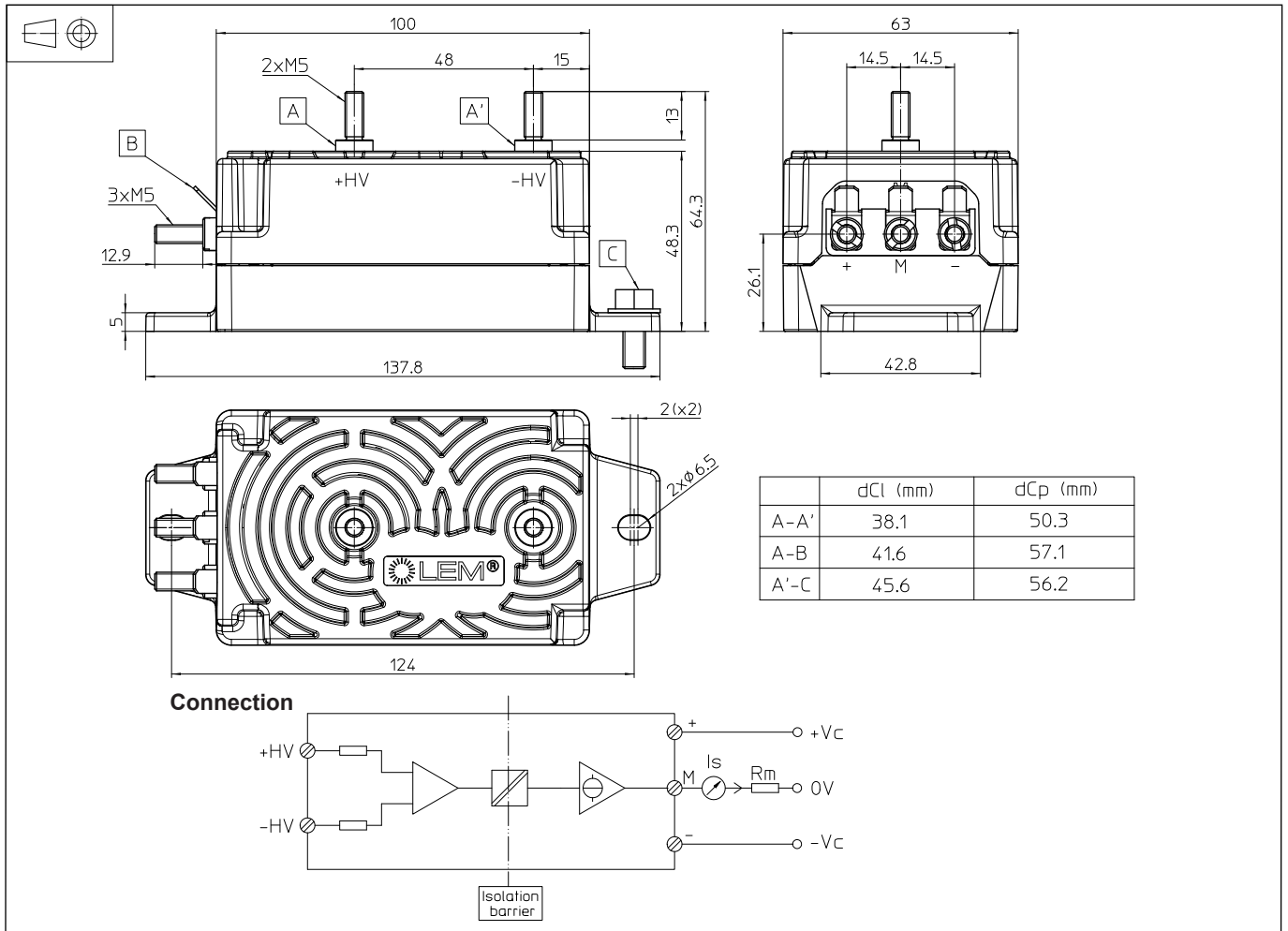

Figure 17: response time t_r and reaction time t_{ra}

Dimensions DVL 750 (in mm.)

Mechanical characteristics

- General tolerance ± 1 mm
- Transducer fastening
 - 2 holes $\varnothing 6.5$ mm
 - 2 M6 steel screws
 - Recommended fastening torque 4 Nm
- Connection of primary
 - 2 M5 threaded studs
 - Recommended fastening torque 2.2 Nm
- Connection of secondary
 - 3 M5 threaded studs
 - Recommended fastening torque 2.2 Nm

Remarks

- I_s is positive when a positive voltage is applied on +HV.
- The transducer is directly connected to the primary voltage.
- The primary cables have to be routed together all the way.
- The secondary cables also have to be routed together all the way.
- Installation of the transducer is to be done without primary or secondary voltage present.

Safety

This transducer must be used in electric/electronic equipment with respect to applicable standards and safety requirements in accordance with the manufacturer's operating instructions.



Caution, risk of electrical shock

When operating the transducer, certain parts of the module can carry hazardous voltage (eg. primary busbar, power supply). Ignoring this warning can lead to injury and/or cause serious damage. This transducer is a build-in device, whose conducting parts must be inaccessible after installation. A protective housing or additional shield could be used. Main supply must be able to be disconnected.